



PARTYBOX 1000





OWNER'S MANUAL

IMPORTANT SAFETY INSTRUCTIONS

For all products:

1. Read these instructions.
2. Keep these instructions.
3. Heed all warnings.
4. Follow all instructions.
5. Do not block any ventilation openings. Install this apparatus in accordance with the manufacturer's instructions.
6. Do not install this apparatus near any heat sources such as radiators, heat registers, stoves or other apparatus (including amplifiers) that produce heat.
7. Do not defeat the safety purpose of the polarized or grounding-type plug. A polarized plug has two blades with one wider than the other. A grounding-type plug has two blades and a third grounding prong. The wide blade or the third prong is provided for your safety. If the provided plug does not fit into your outlet, consult an electrician for replacement of the obsolete outlet.
8. Protect the power cord from being walked on or pinched, particularly at plugs, convenience receptacles and the point where they exit from the apparatus.
9. Use only attachments/accessories specified by the manufacturer.
10. Use only with the cart, stand, tripod, bracket or table specified by the manufacturer or sold with the apparatus. When a cart is used, use caution when moving the cart/apparatus combination to avoid injury from tip-over. 
11. Unplug this apparatus during lightning storms or when unused for long periods of time.
12. To disconnect this apparatus from the AC mains completely, disconnect the power-supply cord plug from the AC receptacle.
13. The mains plug of the power-supply cord shall remain readily operable.
14. Do not expose batteries to excessive heat such as sunshine, fire or the like.
15. This apparatus is intended to be used only with the power supply and/or charging cable provided by the manufacturer.

| CAUTION | |
|---|--|
| RISK OF ELECTRIC SHOCK. DO NOT OPEN. | |
|  | THE LIGHTNING FLASH WITH AN ARROWHEAD SYMBOL, WITHIN AN EQUILATERAL TRIANGLE, IS INTENDED TO ALERT THE USER TO THE PRESENCE OF UNINSULATED "DANGEROUS VOLTAGE" WITHIN THE PRODUCT'S ENCLOSURE THAT MAY BE OF SUFFICIENT MAGNITUDE TO CONSTITUTE A RISK OF ELECTRIC SHOCK TO PERSONS. |
|  | THE EXCLAMATION POINT WITHIN AN EQUILATERAL TRIANGLE IS INTENDED TO ALERT THE USER TO THE PRESENCE OF IMPORTANT OPERATING AND MAINTENANCE (SERVICING) INSTRUCTIONS IN THE LITERATURE ACCOMPANYING THE PRODUCT. |
| WARNING: TO REDUCE THE RISK OF FIRE OR ELECTRIC SHOCK, DO NOT EXPOSE THIS APPARATUS TO RAIN OR MOISTURE. | |

Caution FCC and IC statement for users (USA and Canada only)

This device complies with part 15 of the FCC Rules. Operation is subject to the following two conditions: (1) This device may not cause harmful interference, and (2) this device must accept any interference received, including interference that may cause undesired operation.

CAN ICES-3(B)/NMB-3(B)

Federal Communication Commission Interference Statement

This equipment has been tested and found to comply with the limits for a Class B digital device, pursuant to Part 15 of the FCC Rules. These limits are designed to provide reasonable protection against harmful interference in a residential installation. This equipment generates, uses and can radiate radio frequency energy and, if not installed and used in accordance with the instructions, may cause harmful interference to radio communications. However, there is no guarantee that interference will not occur in a particular installation. If this equipment does cause harmful interference to radio or television reception, which can be determined by turning the equipment off and on, the user is encouraged to try to correct the interference by one or more of the following measures:

- Reorient or relocate the receiving antenna.
- Increase the separation between the equipment and receiver.
- Connect the equipment into an outlet on a circuit different from that to which the receiver is connected.
- Consult the dealer or an experienced radio/TV technician for help.

Caution: Changes or modifications not expressly approved by HARMAN could void the user's authority to operate the equipment.

For Products That Transmit RF Energy

FCC AND IC INFORMATION FOR USERS

This device complies with Part 15 of the FCC rules and Industry Canada license-exempt RSS standard(s). Operation is subject to the following two conditions: (1) This device may not cause harmful interference; and (2) this device must accept any interference received, including interference that may cause undesired operation.

FCC/IC Radiation Exposure Statement

This equipment complies with FCC/IC RSS-102 radiation exposure limits set forth for an uncontrolled environment.

FCC Caution:

High power radars are allocated as primary users of the 5.25 to 5.35 GHz and 5.65 to 5.85 GHz bands. These radar stations can cause interference with and/or damage this device. No configuration controls are provided for this wireless equipment allowing any change in the frequency of operations outside the FCC grant of authorization for US operation according to Part 15.407 of the FCC rules.

IC Caution:

User should also be advised that:

- (i) The device for operation in the band 5150-5250 MHz is only for indoor use to reduce the potential for harmful interference to

co-channel mobile satellite systems; (ii) the maximum antenna gain permitted for devices in the bands 5250-5350 MHz and 5470-5725 MHz shall comply with the e.i.r.p. Limit; and (iii) The maximum antenna gain permitted for devices in the band 5725-5825 MHz shall comply with the e.i.r.p. Limits specified for point-to-point and non-point-to-point operation as appropriate. (iv) Users should also be advised that high-power radars are allocated as primary users (i.e. priority users) of the bands 5250-5350 MHz and 5650-5850 MHz and that these radars could cause interference and/or damage to LE-LAN devices.

Exposure of humans to RF fields (RSS-102)

The computers employ low gain integral antennas that do not emit RF field in excess of Health Canada limits for the general population; consult Safety Code 6, obtainable from Health Canada's Website at <http://www.hc-sc.gc.ca/>

The radiated energy from the antennas connected to the wireless adapters conforms to the IC limit of the RF exposure requirement regarding IC RSS-102, Issue 5 clause 4. SAR tests are conducted using recommended operating positions accepted by the FCC/ RSS with the device transmitting at its highest away from the body. Non-compliance with the above restrictions may result in a violation of FCC RF exposure guidelines.

Use Restriction: Attention in France, the operation is limited to indoor use within the band 5150-5350 Mhz.

For Products with Radio Receivers That Can Use an External Antenna (USA ONLY)

CATV (Cable TV) or Antenna Grounding

If an outside antenna or cable system is connected to this product, be certain that it is grounded so as to provide some protection against voltage surges and static charges. Section 810 of the National Electrical Code (NEC), ANSI/NFPA No. 700-1984, provides information with respect to proper grounding of the mast and supporting structure, grounding of the lead-in wire to an antenna discharge unit, of grounding conductors, location of antenna discharge unit, connection to grounding electrodes and requirements of the electrode.

Note to CATV System Installer

This reminder is provided to call the CATV(cable TV) system installer's attention to article 820-40 of the NEC, which provides guidelines for proper grounding and, in particular, as close to the point of cable entry as possible.

Caution: This product uses a laser system. To prevent direct exposure to the laser, do not open the cabinet enclosure or defeat any of the safety mechanisms provided for your protection. Do NOT START INTO THE LASER BEAM. To ensure proper use of this product, please read the owner's manual carefully and retain it for future use. Should the unit require maintenance or repair, please contact your local JBL service. Refer servicing to qualified personnel only.

CLASS 1 LASER PRODUCT
KLASSE 1 LASER PRODUKT
LUOKAN 1 LASER LAITE
KLASS 1 LASER APPARAT
CLASSE 1 PRODUIT LASER

FOR ALL EU COUNTRIES

For products that include audio out

Prevention of hearing loss



Caution: Permanent hearing loss may occur if earphones or headphones are used at high volume for prolonged periods of time.

For France, the products have been tested to comply with Sound Pressure Level requirement laid down in the applicable NF EN 50332 L.5232-1.

Note:

- To prevent possible hearing damage, do not listen to high volume levels for long periods.

WEEE Notice

The Directive on Waste Electrical Equipment (WEEE), which entered into force as European law on 14/02/2014, resulted in a major change in the treatment of electrical equipment at end-of-life.

The purpose of this Directive is, a first priority, the prevention of WEEE, and in addition, to promote the reuse, recycling and other forms of recovery of such wastes as so as to reduce disposal.

The WEEE logo on the product or on its box indicating collection for electrical and electronic equipment consists of the crossed-out wheeled bin, as shown below.



This product must not be disposed of or dumped with your other household waste. You are liable to dispose of all your electronic or electrical waste equipment by relocating over to the specified collection point for recycling of such hazardous waste. Isolated collection and proper recovery of your electronic and electrical waste equipment at the time of disposal will allow us to help conserving natural resources. Moreover, proper recycling, and collection points, please contact your local city center, household waste disposal service, shop from where you purchased the equipment, or manufacturer of the equipment.

RoHS Compliance

This product is in compliance with Directive 2011/65/EU of the European Parliament and of the Council of 8 June 2011 on the restriction of the use of certain hazardous substances in electrical and electronic equipment.

For Products that includes Batteries

EU Batteries Directive 2013/56/EU

A new battery directive 2013/56/eu on Battery and Accumulator replacing directive entered into force on the 01/07/2015. The directive applies to all types of batteries and accumulator (AA, AAA, button cells, rechargeable packs) including those incorporated into appliances except for military, medical and power tool applications. The directive sets out rules for collection, treatment, recycling and disposal of batteries, and aims to prohibit certain hazardous substances and to improve environmental performance of batteries and all operators in the supply chain.

Instructions for Users on Removal, Recycling and Disposal of Batteries

To remove the batteries from your equipment or remote control, reverse the procedure described in the owner's manual for inserting batteries. For products with a built-in battery that lasts for the lifetime of the product, removal may not be possible for the user. In this case, recycling or recovery, it becomes necessary to replace such a battery, this procedure must be performed by authorized services centers. In the European Union and other locations, it is illegal to dispose of any battery with household trash. All batteries must be disposed of in an environmentally sound manner. Contact your local waste-management officials for information regarding the environmentally sound collection, recycling and disposal of used batteries.

WARNING: Danger of explosion if battery is incorrectly replaced. To reduce risk of fire or burns, don't disassemble, crush, puncture, short external contact, expose to temperature above 60°C (140°F), or dispose of in fire or water. Replace only with specified batteries. The symbol indicating 'separate collection' for all batteries and accumulators shall be crossed-out wheeled bin shown below:



In case of batteries, accumulators and button cells containing more than 0.0005 mercury, more than 0.002% cadmium or more than 0.004% lead, shall be marked with the chemical symbol for the metal concerned: Hg, Cd or Pb respectively. Please Refer to the below symbol:

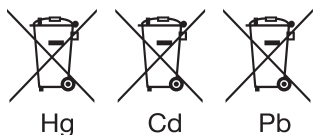

WARNING: DO NOT INGEST BATTERIES, CHEMICAL BURN HAZARD [the remote supplied with] This product contains a coin/button cell battery. If the coin/button cell battery is swallowed, it can cause severe internal burns in just 2 hours and can lead to death. Keep new and used batteries away from children. If you think batteries might have been swallowed or placed inside any part of body, seek immediate medical attention.

For All Products Except Those with Wireless Operation

HARMAN International hereby declares that this equipment is in compliance with EMC 2014/30/EU Directive, LVD 2014/35/EU Directive. The declaration of conformity may be consulted in the support section of our Web Site, accessible from www.jbl.com.

For All Products with Wireless Operation

HARMAN International hereby declares that this equipment is in compliance with the essential requirements and other relevant provisions of Directive 2014/53/EU. The declaration of conformity may be consulted in the support section of our Web Site, accessible from www.jbl.com.

HARMAN

HARMAN International Industries, Incorporated
8500.255.4545 (USA only)

HARMAN International Industries, Incorporated. All rights reserved. JBL is a trademark of HARMAN International Industries, Incorporated, registered in the United States and/ or other countries. Features, specifications and appearance are subject to change without notice.

EPILEPSY WARNING

A few people may experience epileptic seizures when viewing flashing lights.

TABLE OF CONTENTS

| | |
|--------------------------------------|----------|
| IMPORTANT SAFETY INSTRUCTIONS | 2 |
|--------------------------------------|----------|

| | |
|------------------------|----------|
| 1. INTRODUCTION | 6 |
|------------------------|----------|

| | |
|-----------------------------|----------|
| 2. WHAT'S IN THE BOX | 6 |
|-----------------------------|----------|

| | |
|--------------------|----------|
| 3. OVERVIEW | 7 |
|--------------------|----------|

| | |
|---------------|---|
| 3.1 TOP PANEL | 7 |
|---------------|---|

| | |
|------------|---|
| 3.2 DJ PAD | 8 |
|------------|---|

| | |
|----------------|---|
| 3.3 BACK PANEL | 8 |
|----------------|---|

| | |
|---------------------|----------|
| 4. PLACEMENT | 9 |
|---------------------|----------|

| | |
|--------------------|-----------|
| 5. POWER ON | 10 |
|--------------------|-----------|

| | |
|-------------------------------|-----------|
| 6. USING YOUR PARTYBOX | 10 |
|-------------------------------|-----------|

| | |
|--------------------------|----|
| 6.1 BLUETOOTH CONNECTION | 10 |
|--------------------------|----|

| | |
|--------------------|----|
| 6.2 USB CONNECTION | 11 |
|--------------------|----|

| | |
|--------------------|----|
| 6.3 AUX CONNECTION | 11 |
|--------------------|----|

| | |
|-------------|----|
| 6.4 LINE IN | 11 |
|-------------|----|

| | |
|---|----|
| 6.5 MIX SOUND WITH A MICROPHONE OR GUITAR | 11 |
|---|----|

| | |
|------------------------|-----------|
| 7. TRANSPORTING | 12 |
|------------------------|-----------|

| | |
|---------------------------------|-----------|
| 8. AIR GESTURE WRISTBAND | 13 |
|---------------------------------|-----------|

| | |
|--------------------|----|
| 8.1 POWER ON / OFF | 13 |
|--------------------|----|

| | |
|-----------------------|----|
| 8.2 REPLACING BATTERY | 13 |
|-----------------------|----|

| | |
|---|----|
| 8.3 CONTROL PARTYBOX BY USING AIR GESTURE WRISTBAND THROUGH GESTURE | 13 |
|---|----|

| | |
|--------------------|-----------|
| 9. SETTINGS | 14 |
|--------------------|-----------|

| | |
|---------------|----|
| 9.2 DEMO MODE | 14 |
|---------------|----|

| | |
|------------------|----|
| 9.3 STANDBY MODE | 14 |
|------------------|----|

| | |
|---------------------------|-----------|
| 10. SPECIFICATIONS | 14 |
|---------------------------|-----------|

| | |
|-----------------------------|-----------|
| 11. TROUBLESHOOTINGS | 15 |
|-----------------------------|-----------|

| | |
|-----------------------|-----------|
| 12. COMPLIANCE | 15 |
|-----------------------|-----------|

| | |
|----------------------|-----------|
| 13. TRADEMARK | 16 |
|----------------------|-----------|

1. INTRODUCTION

Congratulations on your purchase! This manual includes information on “**JBL PARTYBOX 1000**” speaker. We encourage you to take a few minutes to read this manual, which describes the product and includes step-by-step instructions to help you to set up and get started. Read and understand all the safety instructions before using your product.

If you have any questions about this product, its installation or its operation, please contact your retailer or customer service, or visit us at www.jbl.com

2. WHAT'S IN THE BOX

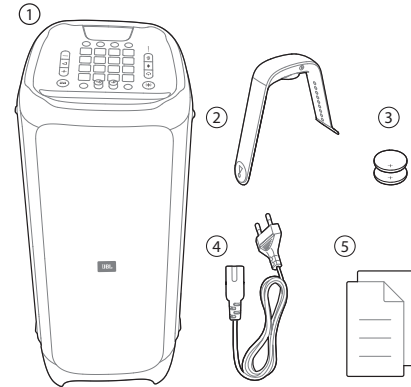

- 1) Main unit
 - 2) Air gesture wristband
 - 3) Air gesture wristband batteries (2x 3V CR2032)
 - 4) Power cord*
 - 5) Quick Start Guide, Safety sheet, Warranty card
- *Power cord quantity and plug type vary by regions.

3. OVERVIEW

3.1 Top Panel

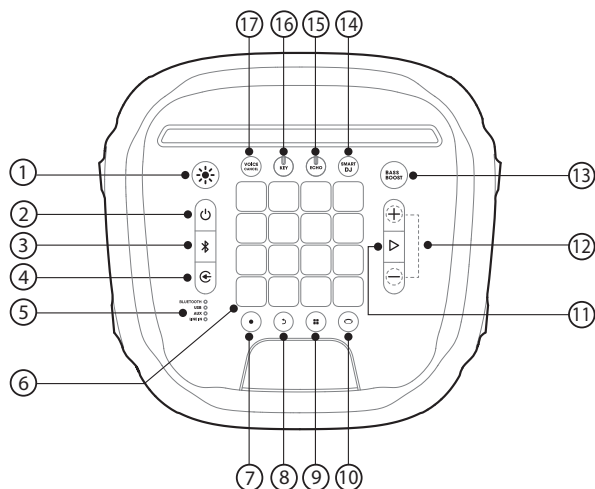

- 1)
 - Press to switch light show patterns.
 - Press and hold for 2 seconds to turn the strobe light on or off.
- 2)
 - Press to power on/off.
- 3)
 - Press to enter Bluetooth pairing mode.
 - Press and hold for 20 seconds to disconnect current device, and pair with a new device.
- 4)
 - Press repeatedly to select a music source (Bluetooth / USB / AUX / LINE IN).
- 5)
 - LED indicators to show the current music source.
- 6)
 - DJ control keys.
- 7)
 - Press to record a new track. Up to 8 tracks can be recorded.
- 8)
 - Press to delete the last recorded track.
 - Press and hold for 2 seconds to delete all recorded tracks.
- 9)
 - Press repeatedly to select a sound effect mode (Drums / Keyboard / Piano / DJ / Customized).
- 10)
 - Press to enter color control mode to toggle between different light colors of the front panel and wristband.

- 11)
 - Press to decrease or increase the volume level.
 - Press both simultaneously to mute the audio output.
- 12)
 - Press to play or pause the music.
 - Press twice to play the next track.
 - Press three times to play the previous track.
- 13) **BASS BOOST**
 - Press repeatedly to switch between sound boost level 1 and level 2 or turn off.
- 14) **SMART DJ**
 - Press to turn the Smart DJ on or off.
- 15) **ECHO**
 - Rotate to adjust echo volume (Plug in a mic to activate the Karaoke mode).
- 16) **KEY**
 - Rotate to adjust the key level (Plug in a mic to activate the Karaoke mode).
- 17) **VOICE CANCEL**
 - Press to cancel or restore the human voice (Plug in a mic to activate the Karaoke mode).

Notes:

- Use the Smart DJ to analyze music rhythm and mix DJ effect like flanging, phasing and chorus.
- Use the Smart DJ to play fast music rhythm (Club, Hip Hope, Techno, etc...)
- With the USB source, Smart DJ broadcast continuous music and fills the void of silence between the two samples.

LED behavior

| | | |
|---------------------|--|---------------|
| | <input type="radio"/> Off | Power off |
| | <input type="radio"/> White (Constant) | Power on |
| | <input type="radio"/> Amber (Constant) | Standby |
| | <input type="radio"/> Off | Not connected |
| | <input type="radio"/> White (Constant) | Connected |
| | <input type="radio"/> White (Flashing) | Pairing |
| BASS BOOST | <input type="radio"/> Off | Off |
| | <input type="radio"/> White (Constant) | On |
| VOICE CANCEL | <input type="radio"/> Off | Off |
| | <input type="radio"/> White (Constant) | On |
| R/L Channel | <input type="radio"/> Off | Off |
| | <input type="radio"/> White (Constant) | On |
| SMART DJ | <input type="radio"/> Off | Off |
| | <input type="radio"/> White (Constant) | On |

Caution:

- Do not look directly at the light-emitting parts when the speaker lights are illuminated or blinking.

3.2 DJ pad

Color control

Press  to enter color control mode, then press any DJ control key to select a color for the light of both PartyBox and wristbands nearby. The color will stay for 5 seconds. To keep the color constant, press and hold for 2 seconds the DJ control keys.

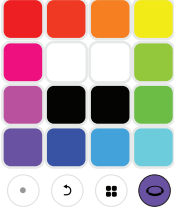

Sound effects

Press  repeatedly to select a sound effect mode (Drums / Keyboard / Piano / DJ / Customized).

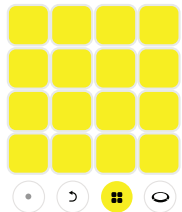

Drums (defaulted)

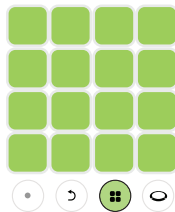

Keyboard

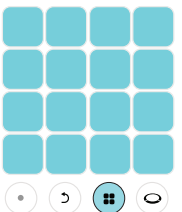

Piano

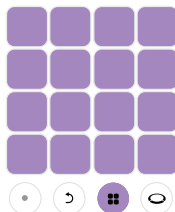



DJ effects

Customized effects



Customized effects (support MP3 format only).

- 1) Insert a USB stick.
- 2) Press  repeatedly to select the USB source.
- 3) Press  repeatedly to select customized effects.
- 4) The sound samples stored in the USB will be loaded. During the loading, all keys will breathe in pink by turns (The samples will be loaded in Alphabetical order, up to 16 samples).

Notes:





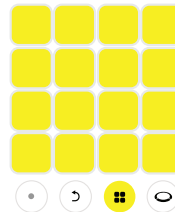

- Support MP3 format only.
- The uploaded samples are limited to a total of 96 seconds among the first 16 samples of the USB stick.
- Once the samples loaded, you can remove the USB stick, the samples will not restore after the power cycle.

MP3 supported format

| Extension | Codec | Sample rate | Bitrate |
|-----------|----------------|-----------------|--|
| MP3 | MPEG1 layer2/3 | 32 / 44.1 / 48 | 32 / 40 / 48 / 56 / 64 / 80 / 96 / 112 / 128 / 160 / 192 / 224 / 256 / 320 |
| | MPEG2 layer2/3 | 16 / 22.05 / 24 | 8 / 16 / 24 / 32 / 40 / 48 / 56 / 64 / 80 / 96 / 112 / 128 / 144 / 160 |
| | MPEG2.5 layer3 | 8 / 11.025 / 12 | 8 / 16 / 24 / 32 / 40 / 48 / 56 / 64 / 80 / 96 / 112 / 128 / 144 / 160 |

Recording



- 1) Press  to start recording, the recording button will be blinking in red.
- 2) Press  to play the DJ Pads.
- 3) Press  to stop the recording, (the recording will automatically stop after 30 seconds).
- 4) Press  to record a new sample. The newly recorded sample will overlap play in a loop with previously recorded samples. The later recorded samples will be shorter or equal to the first sample.
- 5) Press  to delete the last recorded sample. To delete all recorded samples, press and hold  for 2 seconds (Up to 8 tracks can be recorded).

3.3 Back panel

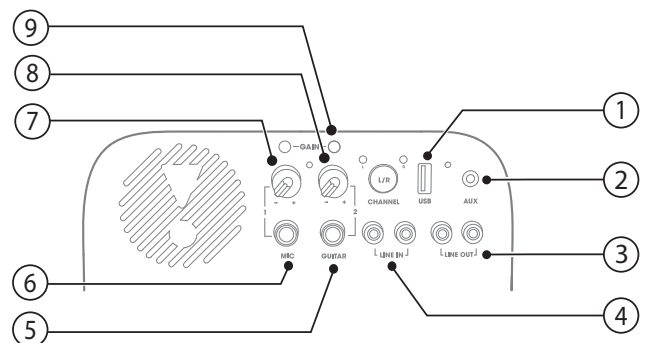

1) USB

- Connect to a USB storage device.
- Charge an external USB device.

2) AUX

- Connect an external audio device with an audio cable.

3) LINE OUT

- Connect to the analog audio input jacks of another analog device with RCA audio cable.

4) LINE IN

- Connect to the analog audio output jacks of an analog device with RCA audio cable.

5) GUITAR

- Connect to a guitar (not provided).

6) MIC

- Connect to a microphone (not provided).

7) VOLUME (MIC)

- Rotate the knob to adjust the mic volume to your desired loudness level.

8) VOLUME (GUITAR)

- Rotate the knob to adjust the guitar volume to your desired loudness level.

9) GAIN

- Guitar and microphone gain control buttons to match different sensitivity.

4. PLACEMENT**Note:**

- Do not sit on the speaker or push it. Otherwise, it may result in malfunction and causing personal injury and /or property damage.

Place the speaker vertically on a flat, stable surface and make sure that the rubber feet side is down.

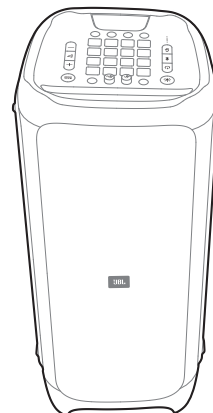

5. POWER ON

Caution:

- Use the provided power cord only.

Plug one end of the power cord into the **POWER** connector on the back of the speaker, then plug the other end to a live AC (mains) outlet.

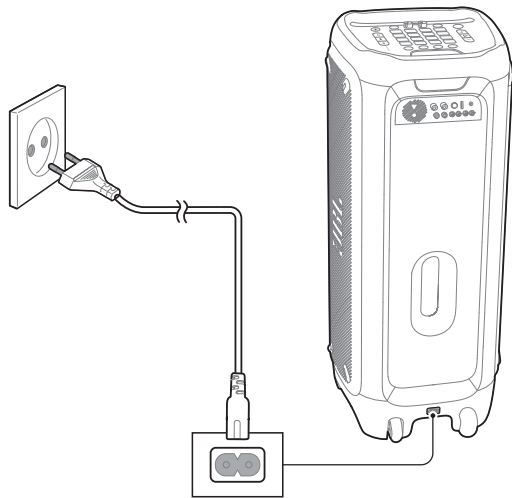

6. USING YOUR PARTYBOX

6.1 Bluetooth connection

You can use your **PartyBox** as an external speaker for your Bluetooth enabled smartphone or tablet.

- 1) Press  to enter Bluetooth pairing mode.
- 2) Select “**JBL PartyBox 1000**” to connect.
- 3) Once successfully connected, audio will stream from your Bluetooth device to this speaker.

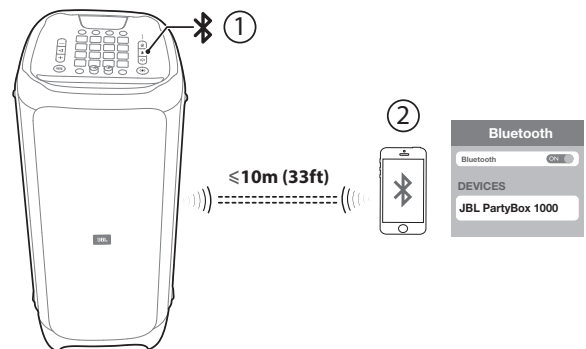

Notes:

- This speaker can memorize a maximum of 8 paired devices. The ninth paired device will replace the first one.
- If a PIN code is requested while connecting a Bluetooth device, enter “0000”.
- Bluetooth performance can be affected by the distance between this product and your Bluetooth device and the environment of operation.

To terminate the Bluetooth-enabled device:

- Turn off this speaker;
- Disable Bluetooth on your device; or
- Move this speaker beyond the Bluetooth operational range.

To reconnect the Bluetooth-enabled device:

- When you turn on this speaker next time, it tries to reconnect the last connected device automatically;
- If not, manually select “**JBL PartyBox 1000**” on your Bluetooth device to start a connection.

6.2 USB connection

With your **PartyBox**, you can enjoy music that is stored on a USB storage device.

Plug your USB storage device into the USB port of your **JBL PartyBox**, and switch to the USB source. The music will play automatically. If not, please check if the USB device supported audio file format listed in below table.

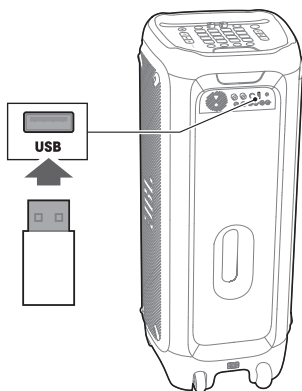

Audio formats

| Extension | Codec | Sample rate | Bitrate |
|-----------|-------------------|--|--|
| WAVE | PCM | 8 / 11.025 / 12 / 16 / 22.05 / 24 / 32 / 44.1 / 48 | 384 / 529.2 / 576 / 768 / 1058.4 / 1152 / 1536 / 2116.8 / 2304 |
| MP3 | MPEG1 layer2/3 | 32 / 44.1 / 48 | 32 / 40 / 48 / 56 / 64 / 80 / 96 / 112 / 128 / 160 / 192 / 224 / 256 / 320 |
| | MPEG2 layer2/3 | 16 / 22.05 / 24 | 8 / 16 / 24 / 32 / 40 / 48 / 56 / 64 / 80 / 96 / 112 / 128 / 144 / 160 |
| | MPEG2.5 layer3 | 8 / 11.025 / 12 | 8 / 16 / 24 / 32 / 40 / 48 / 56 / 64 / 80 / 96 / 112 / 128 / 144 / 160 |
| WMA | | 8 / 11.025 / 16 / 22.05 / 32 / 44.1/48 | 5 / 6 / 8 / 10 / 12 / 16 / 20 / 22 / 32 / 36 / 40 / 44 / 48 / 64 / 80 / 96 / 128 / 160 / 192 / 256 / 320 |

6.3 AUX connection

- 1) Connect an audio cable, and switch to Aux source (not supplied) to:
 - The headphone socket of your portable audio device;
 - The **AUX** connector of this speaker.
- 2) Turn on your portable audio device and it will start playing.

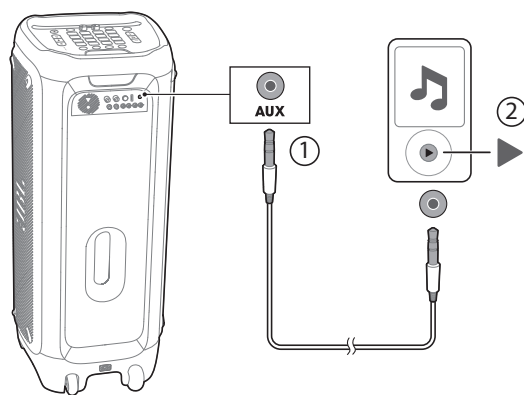

6.4 LINE IN

Connect a pair of **RCA** audio cables (red/white, not supplied) to:

- The **RCA** audio output sockets (red/white) on the analog device (TV, DVD player, etc);
- The **LINE IN (L/R)** connectors on the rear of this speaker.

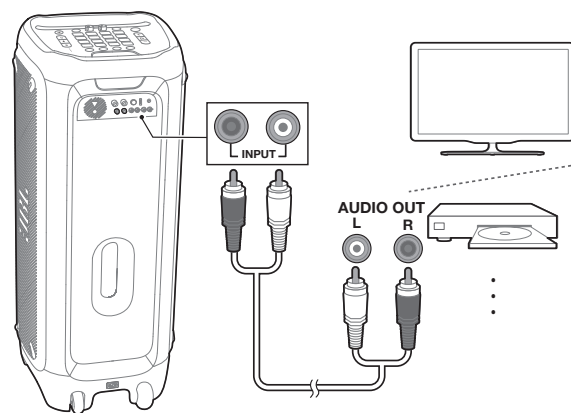

6.5 Mix sound with a microphone or guitar

By using a microphone (not supplied) or an electric guitar (not supplied), you can mix its sound with an audio source.

- 1) Rotate the **MIC/GUITAR** volume knob to adjust the volume to your desired level.
- 2) Connect your microphone or guitar to the **MIC/GUITAR** jack of this speaker.
- 3) Sing through the microphone or play guitar.
 - To adjust the volume of the audio source, press + / -;
 - To adjust the volume of the microphone or guitar, rotate the **MIC/GUITAR** volume knob.

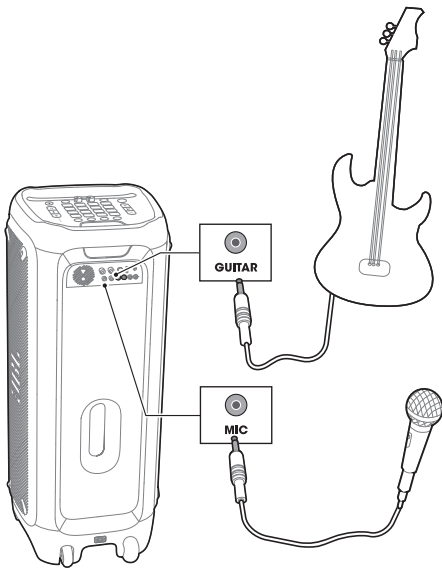

Caution:

- When not using the microphone or guitar, decrease the **MIC/ GUITAR** volume to minimum and remove them from the jack.

7. TRANSPORTING

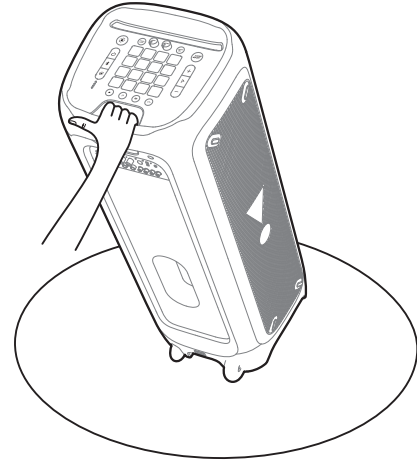

Cautions:

- Before transporting the speaker, make sure that all the cords are disconnected.
- To avoid personal injury and/or property damage, hold the product firmly while transporting.



8. AIR GESTURE WRISTBAND

8.1 Power on / off

- Press  to power on the Air Gesture Wristband, and it will be automatically paired with the PartyBox.
- Press  to power off the Air Gesture Wristband.

8.2 Replacing battery

Note:

- The DJ wristband is powered by batteries. When the wristband battery is down will start flashing in red, after 5 minutes of play will power off.

Open the battery cover in the direction of the arrow until it is completely removed. Insert the batteries (3V) put the battery cover back into position.

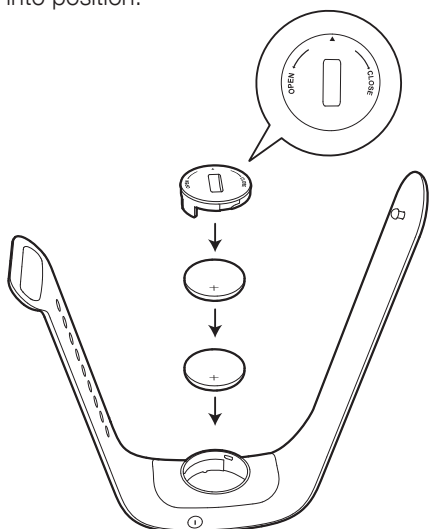

Note:

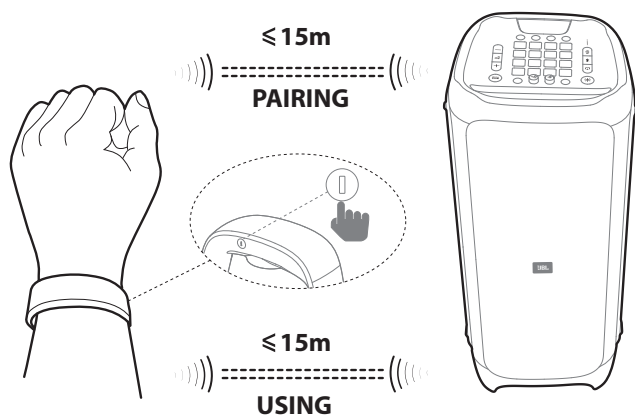

- The Air Gesture Wristband will be connected automatically with the closest PartyBox 1000.



8.3 Control PartyBox by using Air Gesture Wristband through gesture

Note:

- The rotate radius should be more than 20cm.

| Gesture | | Action |
|---------|--|-----------------------|
| Clap |  x2 | Play sound effect 1 |
| Shake |  x4 | Play sound effect 2 |
| Rotate |  | Switch light patterns |

9. SETTINGS

9.1 TWS Mode

The two **PartyBox 1000** speakers can connect to each other in TWS mode.

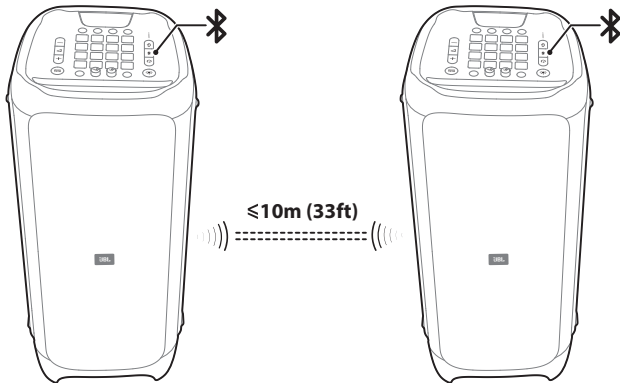



- 1) Press and hold  on both speakers simultaneously for 5 seconds, you will hear a tone to indicate speakers are in pairing mode. Once TWS connection built up, you will hear another tone.
- 2) Press **L/R** button on one speaker to toggle between **L** channel, **R** channel and Stereo, another speaker will change the setting automatically. By default the first one connected to your device will be the primary speaker (L channel), the other one will be the secondary speaker (R channel).

9.2 Demo Mode

Caution:

- Ensure PartyBox is powered by AC to go into Demo Mode.
- If the AC power unplugged, the PartyBox will power off. If the AC power is resumed the PartyBox will automatically enter demo mode.



To enter or to exit demo mode, press and hold  and  simultaneously for 5 seconds.

In demo mode, all the input sources are disabled, all buttons but  /  are disabled.



Note:

- The PartyBox built-in with 3 x 30 seconds music tracks.

Playback

- Press  once to start, pause or resume the play (one sample will be played only for 30 seconds).
- Press  once after the pause, to play the next track.

9.3 Standby Mode

The standby mode function can set only when the speaker is not used for 20 minutes. To exit the standby mode, press  or .

10. SPECIFICATIONS

- Product name: PartyBox 1000
- AC power input: 100-240V ~ 50/60Hz
- Power consumption: 150W
- Standby power consumption: <2W with BT connecting; <0.5W without BT connecting
- USB output: 5V = 2.1A
- Speaker drivers: 1 x 12" Subwoofer + 2 x 7" Mid-range + 1 x Compression driver
- Speaker impedance: Subwoofer 3 ohm / Midrange 4 ohm / Compression driver 4 ohm
- Total output power: 1100W
- Frequency response: 30Hz -20kHz(-6dB)
- Signal-to-noise (S/N) ratio: 80 dBA
- Wristband battery play time: 6h
- Bluetooth version: 4.2
- Bluetooth profile: A2DP V1.3, AVRCP V1.6
- Bluetooth transmitter frequency range: 2402-2480 MHz
- Bluetooth maximum transmitter power: 15dBm (EIRP)
- Bluetooth transmitter modulation: GFSK, $\pi/4$ DQPSK, 8DPSK
- Bluetooth range: Approx. 10m (33 feet)
- USB file system: FAT16, FAT32
- USB file format: .mp3, .wma, .wav
- Air gesture wristband: BLE technology
- Dimensions (W x H x D): 397 x 1050 x 390 mm / 15.6 x 41.3 x 15.4 in
- Net weight: 34.7 kg / 76.5 lbs

11. TROUBLESHOOTINGS

Caution:

- Never try to repair the product by yourself. If you have any problems while using this product, check the following points before you request service.

System

The product will not turn on.

- Check if the power cord is properly plugged into the outlet and to the **PartyBox**.
- For “**Air Gesture Wristband**” replace the battery with a new one and reattempt powering it on.

Sound

No sound from the **PartyBox**.

- Make sure the **PartyBox** is powered on.
- Make sure the volume level is turned to an audible level.
- Make sure that it is connected to a music source. If the music source has a volume, ensure it is turned to an audible level.

Bluetooth

A device cannot connect with the **PartyBox**.

- Check if you enable the Bluetooth function of the device.
- The **PartyBox** is already connected to another Bluetooth device. Press and hold **X** to disconnect and pair with a new device.

Poor audio quality from a connected Bluetooth device.

- The Bluetooth reception is poor. Move the device closer to the **PartyBox**, or remove any obstacle between the device and the **PartyBox**.

12. COMPLIANCE

The product is in compliance with the European Union energy legislation.

Bluetooth connection mode

The product is intended to be used for streaming music via Bluetooth connection. A consumer can stream Bluetooth audio to the speaker. When the product is connected through Bluetooth, the Bluetooth connection must remain active at all times to ensure proper operation.

The product will enter into sleep mode (networked standby), after 20 minutes without operation, the power consumption @ sleep is less than 2.0 Watts, after which it can be re-activated via Bluetooth connection.

Bluetooth disconnection mode

The product will enter into standby mode, after 20 minutes without operation, the power consumption @ standby is less than 0.5 Watts.

13. TRADEMARK



Este equipamento não tem direito à proteção contra interferência prejudicial e não pode causar interferência em sistemas devidamente autorizados.

Este produto está homologado pela ANATEL, de acordo com os procedimentos regulamentados pela Resolução 242/2000, e atende aos requisitos técnicos aplicados.

Para maiores informações, consulte o site da ANATEL – www.anatel.gov.br



The Bluetooth® word mark and logos are registered trademarks owned by Bluetooth SIG, Inc. and any use of such marks by HARMAN International Industries, Incorporated is under license. Other trademarks and trade names are those of their respective owners.

| | |
|--------------------------------|--|
| Торговая марка | : JBL |
| Назначение товара | : Активная акустическая система |
| Изготовитель | : Харман Интернешнл Индастриз Инкорпорейтед, США, 06901 Коннектикут, г.Стэмфорд, Атлантик Стрит 400, офис 1500 |
| Страна происхождения | : Китай |
| Импортер в Россию | : ООО "ХАРМАН РУС СиАйЭс", Россия, 127018, г.Москва, ул. Двинцев, д.12, к 1 |
| Гарантийный период | : 1 год |
| Информация о сервисных центрах | : www.harman.com/ru тел. +7-800-700-0467 |
| Срок службы | : 5 лет |

Товар сертифицирован



Дата производства : Дата изготовления устройства определяется по двум буквенным обозначениям из второй группы символов серийного номера изделия, следующих после разделительного знака «-». Кодировка соответствует порядку букв латинского алфавита, начиная с января 2010 года: 000000-MY0000000, где «M» - месяц производства (A - январь, B - февраль, C - март и т.д.) и «Y» - год производства (A - 2010, B - 2011, C - 2012 и т.д.).

Используйте устройство только по прямому назначению в соответствии с предоставленной инструкцией. Не пытайтесь самостоятельно вскрывать корпус товара и осуществлять ремонт. В случае обнаружения недостатков или дефектов, обращайтесь за гарантийным обслуживанием в соответствии с информацией из гарантийного талона. Особые условия хранения, реализации и (или) транспортировки не предусмотрены. Избегайте воздействия экстремальных температур, длительного воздействия влаги, сильных магнитных полей. Устройство предназначено для работы в жилых зонах. Срок годности не ограничен при соблюдении условий хранения.



HARMAN International Industries,
Incorporated 8500 Balboa
Boulevard, Northridge, CA 91329
USA
www.jbl.com

© 2022 HARMAN International Industries, Incorporated. All rights reserved. JBL is a trademark of HARMAN International Industries, Incorporated, registered in the United States and/or other countries. Features, specifications and appearance are subject to change without notice.